

IREX

Pellistor exchange IR gas detector

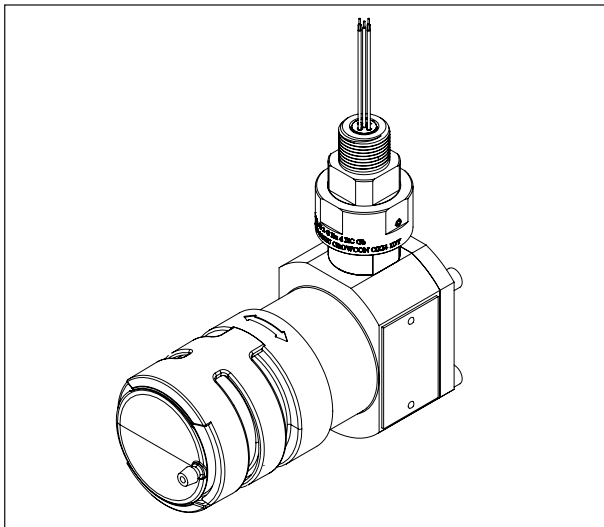

Installation, operating and maintenance instructions

M07690

Issue 2 November 2011

Contents

IRES Concept	1
Safety Information	1
Product overview	2
1. Introduction	3
1.1 Product description	3
2. Installation	
2.1 Location	5
2.2 Mounting	5
2.3 Procedure for replacing an existing pellistor detector	6
2.4 Cabling directly to IRES	7
2.5 Cabling requirement	9
2.6 Connections and settings	10
3. Operation	
3.1 Commissioning procedure	11
3.2 Routine maintenance	12
3.3 Changing gas types	12
3.4 Relative responses of gas types	13
4. Specification	14
5. Spare parts and accessories	15
6. Fault finding	16
Warranty	17

IREX Concept

IREX is an Exd Flameproof gas detector, designed for detecting hydrocarbon gases.

IREX is a sinter-free, fully-featured infrared gas detector that produces a mV Wheatstone Bridge output as used on conventional pellistor based systems.

IREX replaces old pellistor heads by simply mounting on the original junction box, and connecting to the original cable. The IREX concept enables upgrade to dual-wavelength IR gas detector technology without incurring the very significant costs associated with replacing the control system and re-installation.

Safety information

- IREX gas detectors must be installed, operated and maintained in strict accordance with these instructions, warnings, label information, and within the limitations stated.
- The rear plate on IREX must be kept tightly closed until power to the detector is isolated - otherwise ignition of a flammable atmosphere can occur. Before removing the cover for maintenance or calibration purposes, ensure the surrounding atmosphere is free of flammable gases or vapours.
- Maintenance and calibration operations must only be performed by qualified service personnel.
- Only genuine Crowcon replacement parts must be used; substitute components may invalidate the certification and warranty of the detector.
- IREX detectors must be protected from extreme vibration, and direct sunlight in hot environments as this may cause the temperature of the detector to rise above its specified limits and cause premature failure.
- IREX will not detect hydrogen, ammonia or carbon dioxide.

Product overview

IREX is an infrared gas detector designed for detecting common hydrocarbon gases in the range 0 to 100%LEL (Lower Explosive Limit: the minimum concentration in air at which ignition can occur).

IREX is a certified Flameproof (Exd) detector suitable for use in ATEX Zone 1 or Zone 2 hazardous areas. Please refer to the certification label on the side of the detector to identify the type of certification that relates to the product supplied.

Note: if no certification label is fitted to the IREX, the detector is not certified for use in hazardous areas.

The equipment must be earthed using the earth tag provided.

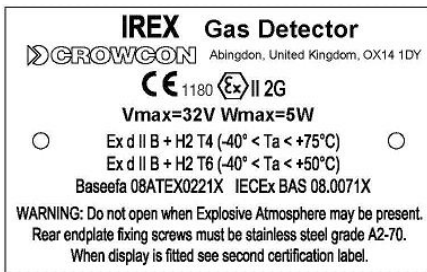

Diagram 1: IREX certification label

Introduction

The configuration of each IREX is identified by a label fitted on the main body. Please quote the product name, part number and serial number when contacting Crowcon for advice or spares.

1.1 Product description

IREX comprises a main body of 316 stainless steel, an antistatic weatherproof cover over the optics and gas measurement chamber, an electronics assembly and a thick stainless steel rear cover plate.

An optional connection spigot gland is supplied to allow IREX to be fitted directly to junction boxes with either M20 or 1/2" NPT cable entries.

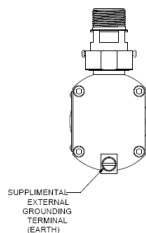
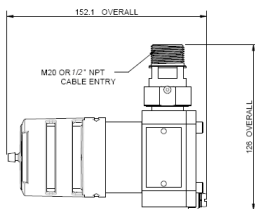
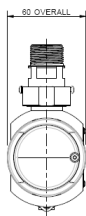
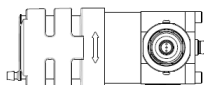

All dimensions in millimetres

Diagram 2: IREX dimensioned view

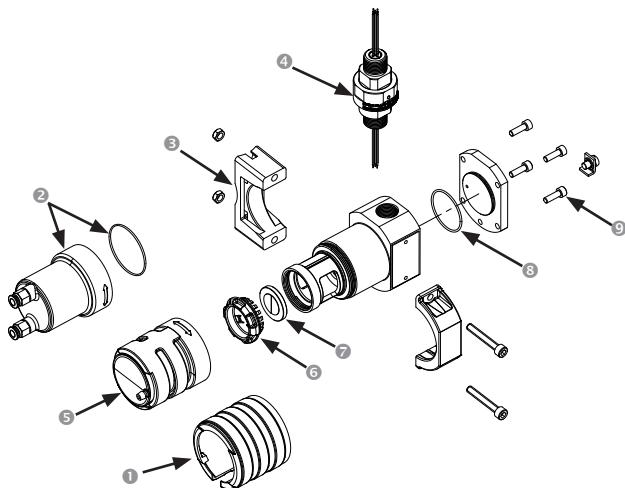

- ① Calibration cap (M041007)
 - ② Flow adaptor (S012996)
 - ③ Mounting bracket (S012130)
 - ④ M20 spigot gland assembly (S012147)
 - ⑤ Weatherproof cover assembly (M04995)
 - ⑥ Mirror retainer
 - ⑦ IREX coated 32 mm mirror
 - ⑧ O-ring (M04998)
 - ⑨ M5 x 16 mm Cap head screw (M03817)
- } Supplied as one part: C011206

Diagram 3: IREX exploded view (part numbers shown in brackets where applicable)

WARNING

This detector is designed for use in Zone 1 and Zone 2 hazardous areas, and is certified  II 2 G Ex d IIB+H2 T4 (-40 to +75°C) or T6 (-40 to +50°C). Installation must be in accordance with the recognised standards of the appropriate authority in the country concerned.

For further information please contact Crowcon. Prior to carrying out any installation work ensure local regulations and site procedures are followed. The equipment must be earthed using the earth tag provided.

2.1 Location

The detector should be mounted where the gas to be detected is most likely to be present. The following points should be noted when locating gas detectors:

- To detect gases which are lighter than air, such as methane, detectors should be mounted at high level. To detect heavier-than-air gases, such as flammable vapours, detectors should be mounted at low level.
- When locating detectors consider the possible damage caused by natural events e.g. rain or flooding. For detectors mounted outdoors in very hot regions Crowcon recommend the use of a sunshade.
- Consider ease of access for functional testing and servicing.
- Consider how the escaping gas may behave due to natural or forced air currents. Mount detectors in ventilation ducts if appropriate (using the IREX duct mounting kit).
- Consider the process conditions. For example, butane is normally heavier than air, but if released from a process which is at an elevated temperature and/or pressure, the gas may rise rather than fall.

The placement of sensors should be determined following advice of experts having specialist knowledge of gas dispersion, the plant processing equipment as well as safety and engineering issues. The agreement reached on the locations of sensors should be recorded.

2.2 Mounting

IREX is designed to replace pellistor detector heads. Where appropriate IREX can be directly re-fitted to the original Exe certified detector junction box, using the M20 spigot gland (1/2" NPT optional) supplied. IREX should be installed at the designated location with the sensor barrel horizontal $\pm 15^\circ$ (orientation shown in Diagram 2 on page 3). This ensures that dust or water will not collect on the optical components.

2.3 Procedure for replacing an existing pellistor detector

IREX is supplied with an M20 spigot gland ($1/2$ " NPT optional) to enable fitment to existing detector function boxes. Once the original detector has been removed,

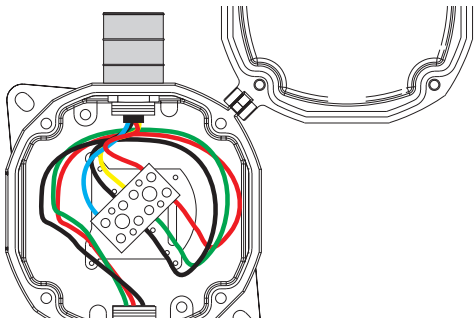

IREX can be fitted and connected to the original cable terminals.

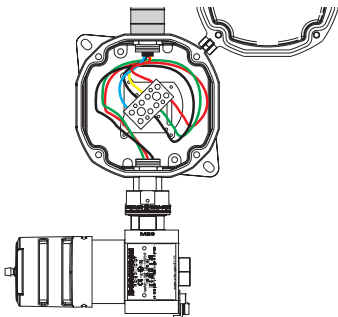

The control card can then be set up and calibrated as before.

1. Connecting IREX to an existing junction box.
 - a. First isolate the power to the detector. Then open the junction box cover. Remove the wires of the detector head from the terminals. Unscrew and remove the detector head.

- b. Carefully remove the outer section of the spigot gland (item 5 or 6) on the exploded diagram on page 5) by loosening the grub screw and then unscrewing from the outer collar.
- c. Screw the narrow end of the spigot gland into the detector junction box.
- d. Raise the IREX to the detector junction box and pass the wires through the assembly and into the junction box. Secure the detector by screwing the collar tightly to the spigot gland. Once the collar has been tightened, re-secure the grub screw.
- e. The main body of the detector can be swivelled horizontally at any angle, provided it is mechanically secure, does not interfere with other equipment and is accessible for maintenance.
- f. Refer to the following section (2.4) for instructions on wiring. See also Diagram 4 (page 6).

2.4 Cabling directly to IREX

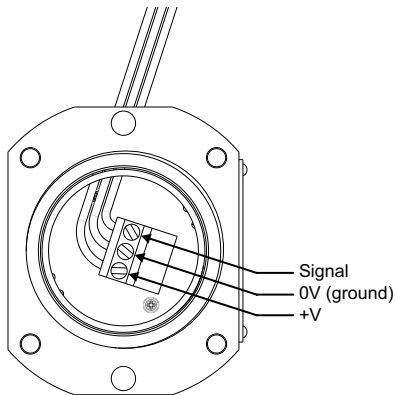

Diagram 4: IREX rear view with back-plate removed

Catalytic sensors have a positive lead, a 0 V lead and a signal lead.

With the cable coming in through the top of the enclosure, power is in the left, 0 V in the middle and signal is on the right.

The 6-pin connection at the bottom left of the PCB is for servicing.

The 3-core cable originally connected to the pellistor detector should be re-terminated to **IREX** as shown.

+ve terminal: +ve supply from the control card.

Sig terminal: Signal/Sense from control card.

0 V terminal: -ve supply from the control card.

IREX can be supplied without a spigot gland, and with a mounting bracket so that it can be directly connected to field cables.

If the detector is to be mounted on a flat surface, mark and drill two holes using the mounting bracket as a template. Loosely fix two parts of the bracket using fixings suitable for the wall/surface.

Remove the weatherproof cap from the **IREX** detector, and slide the body of the detector through the bracket. It is recommended that the detector body is installed with the cable entry facing downwards.

Secure the two bracket fixings so that the detector is held firmly in place. Re-fit the weatherproof cap.

Once the detector is securely fixed in place, remove the **IREX** rear plate to enable access to the cable terminals.

Prepare the field cable – Crowcon recommends 1.5 mm² Steel Wire Armoured (SWA) cable (other cable types may be used provided they are compatible with Exd certified glands). Fit a suitably certified Exd cable gland, pass the cable conductors through the body of the **IREX** and screw in the cable gland. Secure the gland and ensure the cable armour is grounded to the cable gland and the **IREX** body.

NB. Don't forget to re-fit rear plate after installing the cable.

2.5 Cabling requirement

Cabling to IREX must be in accordance with the recognised standards of the appropriate authority in the country concerned and meet the electrical requirements of the detector.

Crowcon recommends the use of steel wire armoured (SWA) cable and suitable explosion proof glands must be used. Alternative cabling techniques, such as steel conduit, may be acceptable provided appropriate standards are met.

The maximum recommended cable length is 2.7 km (see table 1).

IREX mV requires a minimum dc supply of 2.95 V at 330 mA. Pellistor sensor control modules typically have a head voltage/current potentiometer, which should be set so that the voltage at the detector is between **2.95** and **3.2** Volts dc.

Ensure the supply voltage is at least 2.95 V between + and – terminals at the detector. This will take into account the voltage drop due to cable resistance.

Control panels can drive different cable lengths depending on their maximum compliance voltage. Using the DI 800 as an example. A 1.5 mm² cable will typically allow cable runs up to 1.65 km. Table 1 below shows the maximum cable distances given typical cable parameters.

C.S.A.	Resistance	Max. Distance
mm ²	(Ohms per km)	(km)
1.0	18.1	1.1
1.5	12.1	1.65
2.5	7.4	2.7

Table 1: maximum cable distances for typical cables

2.6 Connections and settings

IREX can be set to provide a falling or rising signal, for compatibility with the requirements of different control cards (see Table 2 on facing page). The required signal direction should be supplied when ordering IREX.

The signal direction is changed using the links located on rear/terminal PCB (see diagram 5 below).

Note: The external grounding terminal is only to be used where local authorities permit or require such a connection. Where possible, to limit radio frequency interference, the junction box and cable armour should be grounded at the control panel (safe area) only to avoid earth loops.

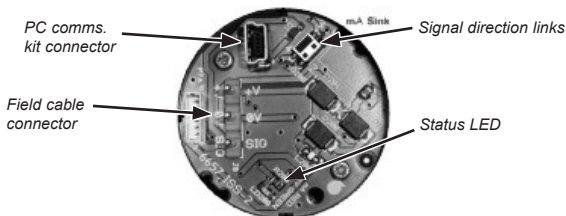

Diagram 5: Signal direction jumper location.

To change the signal direction, remove both links, rotate 90° and re-fit. The IREX detector must be re-zeroed and calibrated if the links are adjusted.

LED indication: a status LED is fitted to the terminal PCB to indicate current operating status (see page 16 for details).

WARNING

Prior to carrying out any work ensure local regulations and site procedures are followed. Never attempt to open the detector or junction box when flammable gas is present. Ensure that the associated control panel is inhibited so as to prevent false alarms.

3.1 Commissioning procedure

1. Check that:
 - a. The cable connections are correct
 - b. The supply voltage is set at the control card. The voltage measured at the detector terminals (within the Exe junction box if used, or at the **IREX** terminal PCB) and must be set between **2.95** and **3.2 V**. If the voltage is set too low, the **IREX** will flash a 'low power' pattern on the LED. The maximum supply voltage as measured at the **IREX** terminals **must not exceed 3.6 V**.
 - c. The links are set for rising/falling as appropriate to control card.
 - d. Check on the specification sheet supplied with the detector that the output signal is set to rise or fall as appropriate to the control card to which it is to be connected. Two examples are given below.

Control card	Signal direction
DI-800	Falling
Wormald 2003A-1	Rising

Table 2

2. Once powered up leave for 30 minutes, before attempting zero/cal. This delay is to ensure thermal stability. (Note: **IREX** will be fully operational from 30 seconds after power.
3. Ensure clean air (i.e. no hydrocarbon gas). Zero reading at control card (refer to control card instructions).
4. Fit calibration cap over waterproof cover to isolate measurement chamber from ambient air. Connect calibration gas (50% LEL nom) and apply at 1 litre-per-minute flow.
5. After 30 seconds adjust cal/span potentiometer on control card so that display reads 50% (LEL), or matches concentration of cal. gas applied.
6. Remove gas, calibration cap, re-check zero.

Note: ATEX Certified **IREX** detectors will be supplied calibrated for compliance with EN61779 (where, for example 100% LEL Methane = 4.4% volume).

Note: it is recommended that the calibration cap is used for initial commissioning. Subsequent calibrations may be conducted by applying gas to the weatherproof cap remotely via the pipe spigot (thus avoiding the need to directly access the detector).

3.2 Routine maintenance

Site practices will dictate the frequency with which detectors are tested. Crowcon recommends that detectors are gas tested at least every 6 months and re-calibrated as necessary. To re-calibrate a detector follow the steps given in 3.1.

In the event of an electronic failure please consult your local Crowcon representative.

- Calibration interval: Crowcon recommend calibration every 12 months.
- Remote cal via pipe: Wind speed should be less than 2.0 metres per second. If greater, use the calibration cap to prevent gas dilution.
- Cleaning of optics: It is not recommended unless the detector is in fault. If the window or mirror becomes contaminated clean carefully using a mirror cleaning kit (part number C011210).
- Mirrors: If the mirror is damaged, obtain a mirror replacement kit (see Section 5, **Accessories and spare parts** on page 15). The **IREX** must always be re-zeroed and re-calibrated after mirror replacement.
- If condensation starts to cause faults, replace the mirror (the optical coating may be damaged). **Crowcon** recommends replacing the mirror every 5 years
- Optional dust filter: If fitted, must regularly be tested to ensure filter has not become blocked. Filters must be replaced regularly. Test by applying calibration gas to gassing spigot to verify the detector responds.
Warning: when using optional calibration cap, do not forget to take it off after use!

3.3 Changing gas types

Each IREX detector is supplied pre-calibrated for a particular type of gas (for example methane or propane). If re-calibration for a different gas type is required, the IREX detector should be returned to Crowcon for modification.

3.4 Relative responses of gas types

This graph is for a positive going IREX.

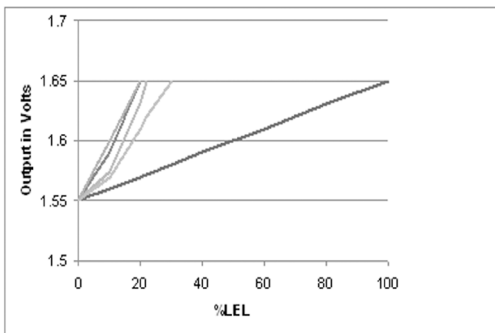

It shows the relative responses to other gas types for an IREX calibrated on methane.

Please note that pentane, butane, propane and ethane all have greater responses from IREX than methane.



The diagram shows the response of the gases mentioned above: from left to right, ethane, propane, butane, pentane and methane.

4. Specification

<i>Enclosure material</i>	316 Stainless Steel
<i>Dimensions</i>	150 mm x 75 mm x 60 mm (without spigot)
<i>Weight</i>	Stainless steel: 1.4 kg
<i>Operating voltage</i>	2.9 V dc to 3.2 V dc
<i>Power</i>	< 1 W
<i>Output</i>	3-wire mV Typically 10-20 mV per %vol methane
<i>Fault signal</i>	100% LEL equivalent
<i>Maximum cable loop resistance Relative to -ve terminal (common)</i>	20 Ohms
<i>Operating temperature</i>	-40°C to +75°C (-40°F to +167°F)
<i>Humidity</i>	0–100% RH
<i>Degree of protection</i>	IP66
<i>Explosion protection</i>	Flameproof
<i>Approval code</i>	ATEX  II 2 G Exd IIB + H ₂ T6 T _{amb} = -40°C to 50°C ATEX  II 2 G Exd IIB + H ₂ T4 T _{amb} = -40°C to +75°C
<i>Safety certificate no.</i>	Baseefa 08ATEX0221X and IECEX BAS.08.0071X
<i>Standards</i>	EN60079-0:2006, EN60079-1:2004
<i>Zones</i>	Certified for use in Zone 1 or Zone 2
<i>EMC</i>	EN50270

5. Spare parts and accessories

Accessories

Part Numbers	Name	Description
M041007	Calibration cap	Fits over the standard weathercap to enable calibration where local air speed exceeds 2 metres per second.
S012130	Mounting bracket kit	Enables mounting to a wall or 2" (50 mm) pipe. Not required if IREX is being fitted to an existing junction box.
M041004	Dust filter	Fits within the standard weatherproof cap to prevent ingress to the optical chamber from fine particulates.
S012152	Sun shade/Collector Cone	Can be fitted to IREX to protect against elevated temperatures due to direct sunlight and/or to extend the detectors footprint for detecting lighter than air gases (methane).
S012169	Duct mounting kit	Enables monitoring of ducts from 200 mm to 3000 mm, and air-flow between 2 m/s and 25 m/s.
S012996	Flow adaptor	For gas sampling applications.
S012828	PC Interface kit	Software CD and lead to enable configuration of the detector.
C011210	Mirror cleaning kit	Contains IPA impregnated wipes and a microfibre cloth.

IREX Spares

Refer to Diagram 3 on page 4 for details of spare parts.

6. Fault finding IREX

Symptom/error message	Cause	Action
Control card goes into fault:		Check optical components are clean. Check detector supply voltage.
The PC software will read the status error codes and may report the following errors:		
Sensor obscuration		Check mirror
IREX in warm-up		Wait for warm-up to complete
Zero fault		Re-zero and calibrate
Span fault		Re-zero and calibrate
Low power		Adjust control panel
Gas reading on control card goes negative when gas is applied to IREX.	Signal jumpers are incorrectly set (refer to section 2.6).	Remove the IREX back plate (having observed local hot-work instructions) to access the IREX rear/terminal PCB. Remove both links (see diagram 5, page 10), rotate 90° and re-fit. Re-secure the IREX back-plate before re-applying power. The IREX detector must be re-zeroed and calibrated if the links are adjusted

Status LED functions

LED permanently on	Fault
Fast LED flash	Low power
On with little blips off	Startup
Long long short blip each second	Optics fault
Short blip each second	Warning
Regular flash each second	OK

Table 3

Any other faults can only be rectified by returning the detector to Crowcon or authorized service agent.

This equipment leaves our factory fully tested and calibrated. If within the warranty period of three years from Despatch, the equipment is proved to be defective by reason of faulty workmanship or material, we undertake at our option either to repair or replace it free of charge, subject to the conditions below.

Warranty Procedure

To facilitate efficient processing of any claim, contact our customer support team on +44 (0)1235 557711 with the following information:

Your contact name, phone number, fax number and email address.

Description and quantity of goods being returned, including any accessories.

Instrument serial number(s).

Reason for return.

Obtain a Returns form for identification and traceability purpose. This form may be downloaded from our website 'crowconsupport.com', along with a returns label, alternatively we can 'email' you a copy.

Instruments will not be accepted for warranty without a Crowcon Returns Number ("CRN"). It is essential that the address label is securely attached to the outer packaging of the returned goods.

The guarantee will be rendered invalid if the instrument is found to have been altered, modified, dismantled, or tampered with. The warranty does not cover misuse or abuse of the unit.

Warranty Disclaimer

Crowcon accept no liability for consequential or indirect loss or damage howsoever arising (including any loss or damage arising out of the use of the instrument) and all liability in respect of any third party is expressly excluded.

This warranty does not cover the accuracy of the calibration of the unit or the cosmetic finish of the product. The unit must be maintained in accordance with the Operating and Maintenance Instructions.

The warranty on replacement consumable items (such as the mirror) supplied under warranty to replace faulty items, will be limited to the unexpired warranty of the original supplied item.

Crowcon reserves the right to determine a reduced warranty period, or decline a warranty period for any sensor supplied for use in an environment or for an application known to carry risk of degradation or damage to the sensor.

Our liability in respect of defective equipment shall be limited to the obligations set out in the guarantee and any extended warranty, condition or statement, express or implied statutory or otherwise as to the merchantable quality of our equipment or its fitness for

any particular purpose is excluded except as prohibited by statute. This guarantee shall not affect a customer's statutory rights.

Crowcon reserves the right to apply a handling and carriage charge whereby units returned as faulty, are found to require only normal calibration or servicing, which the customer then declines to proceed with.

For warranty and technical support enquiries please contact:

Customer Support

Tel +44 (0) 1235 557711

Fax +44 (0) 1235 557722

Email warranty@crowcon.com



A HALMA COMPANY

UK Office

Crowcon Detection Instruments Ltd
2 Blacklands Way,
Abingdon Business Park
Abingdon
Oxfordshire OX14 1DY
United Kingdom
Tel: +44 (0)1235 557700
Fax: +44 (0)1235 557749
Email: sales@crowcon.com
Web site: www.crowcon.com

Netherlands Office

Crowcon Detection Instruments Ltd
Vlambloem 129
3068JG, Rotterdam
Netherlands
Tel: +31 10 421 1232
Fax: +31 10 421 0542
Email: eu@crowcon.com
Web site: www.crowcon.com

USA Office

Crowcon Detection Instruments Ltd
21 Kenton Lands Road,
Erlanger,
Kentucky 41018-1845
USA
Tel: +1 859 957 1039 or
1-800-527 6926
1-800-5-CROWCON
Fax: +1 859 957 1044
Email: salesusa@crowcon.com
Web site: www.crowcon.com

Singapore Office

Crowcon Detection Instruments Ltd
Block 194, Pandan Loop
#06-20 Pantech Industrial Complex
Singapore 128383
Tel: +65 6745 2936
Fax: +65 6745 0467
Email: sales@crowcon.com.sg
Web site: www.crowcon.com

China Office

Unit 316, Area 1, Tower B,
Chuangxin Building,
12 Hongda North Road,
Beijing Economic & Technological
Development Area,
Beijing, PRC 100176
Tel: +86 10 6787 0335
Email: saleschina@crowcon.com
Web site: www.crowcon.com