

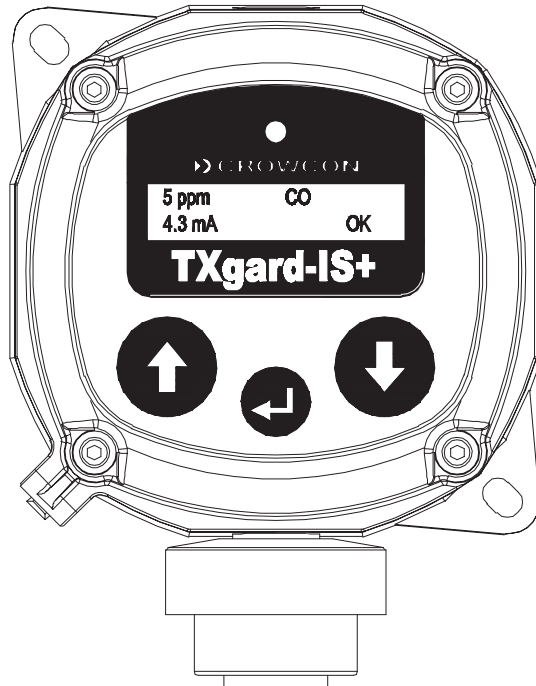

TXgard-IS+
Intrinsically Safe
Toxic and Oxygen Gas Detectors



Loop Powered Electrochemical and Galvanic Sensor Types Only

**Installation, operating and
maintenance instructions, M07214**

Issue 7 January 2010

A HALMA COMPANY



UK Office

Crowcon Detection Instruments Ltd
2 Blacklands Way,
Abingdon Business Park
Abingdon
Oxfordshire OX14 1DY
United Kingdom
Tel:+44 (0)1235 557700
Fax:+44 (0)1235 557749
Email: sales@crowcon.com
Web site: www.crowcon.com

Rotterdam Office

Crowcon Detection Instruments Ltd
Vlambloem 129
3068JG, Rotterdam
Netherlands
Tel:+31 10 421 1232
Fax:+31 10 421 0542
Email: eu@crowcon.com
Web site: www.crowcon.com

USA Office

Crowcon Detection Instruments Ltd
21 Kenton Lands Road,
Erlanger,
Kentucky 41018-1845
USA
Tel:+1 800 527 6926 or
1-800-5-CROWCON
+1 859 957 1039
Fax:+1 859 957 1044
Email: salesusa@crowcon.com
Web site: www.crowcon.us

Singapore Office

Crowcon Detection Instruments Ltd
Block 194, Pandan Loop
#06-20 Pantech Industrial Complex
Singapore 128383
Tel:+65 6745 2936
Fax:+65 6745 0467
Email: sales@crowcon.com.sg
Web site: www.crowcon.com

Contents

1	Introduction	5
	Product overview	5
	Product description	5
2	Installation	8
	General	8
	Mounting	9
	Cabling requirement	9
	Electrical connections	10
3	Operation	13
	The operator display panel and keypad	13
	Using the TXgard-IS+ menus	14
4	Commissioning	16
	Commissioning procedure:	
	Toxic gas detectors	16
	Commissioning procedure:	
	Oxygen detector	21
5	Maintenance	24
	Routine maintenance	24
	Sensor replacement and servicing of detectors	24
6	Fault finding	26

Appendices

Appendix A	<i>Wiring the TXgard-IS+ to Crowcon control equipment</i>	<i>31</i>
Appendix B	<i>TXgard-IS+ specification.....</i>	<i>35</i>
Appendix C	<i>Spare parts</i>	<i>37</i>
Appendix D	<i>Menu system.....</i>	<i>38</i>
Appendix E	<i>4-20 mA Loops.....</i>	<i>46</i>
Appendix F	<i>Cabling requirement.....</i>	<i>48</i>
Appendix G	<i>Sensor limitations.....</i>	<i>51</i>
	<i>Warranty Statement.....</i>	<i>51</i>

1 INTRODUCTION

1.1 Product overview

TXgard-IS+ is an Intrinsically Safe detector for toxic gases or oxygen. It is suitable for use in Zone 0, 1 or 2, or Division 1/Division 2 hazardous areas when used with a suitable Zener barrier or galvanic isolator.

TXgard-IS+ is designed to detect a wide range of gases when fitted with the appropriate electrochemical sensor. Gases include oxygen, carbon monoxide and hydrogen sulphide. For a full list of supported sensors, please contact Crowcon.

TXgard-IS+ is a loop-powered instrument providing a 4-20 mA signal suitable for direct connection to a control panel. Unlike most other 4-20 mA gas detectors featuring operator display panel (LCD) and keypads, it combines its power and signal in just two wires, so only one barrier is required. The instruments are supplied with the mA pre-calibrated, so the mA does not need re-calibration in the field. The keypad and operator display panel allow access to many powerful features to help installation and maintenance, such as:

- true one man calibration
- signal current can be ramped to a desired value to help set-up control panels
- configurable fault and inhibit currents
- configurable display options
- displaying line voltage - no need to access test points inside unit

1.2 Product description

TXgard-IS+ comprises of two main parts. The junction box contains the circuitry, including the PCBs, an operator display panel and keypad. The sensor is contained in the sensor housing. "Figure 1.1" on page 6.

The sensor comes in a re-usable bayonet sensor housing which is standard for all gas sensors.

The sensor housing screws into an M20 entry on the junction box.

All electrical connections to the detector are made through the terminal blocks on the baseboard J2 and J4 (see ③ and ⑥ in "Figure 1.1" on page 5). The junction box of TXgard-IS+ has one top-entry M20 cable

entry for customer use as standard. Side entry versions and gland adapters are available (contact Crowcon for details).

The Personality Module ④, mounted on the baseboard, comes in two varieties: Toxic and Oxygen. It converts the sensor output into a standard signal which can be interpreted by the processor. The Personality Module contains a memory chip with calibration data for the associated sensor. When replacing a sensor, it is not necessary to change the Personality Module; you simply rezero (*Note: not necessary for O₂ sensor*) and recalibrate, and the Personality Module stores the new calibration constants.

When the detector is powered through a suitable Zener barrier or galvanic isolator, the system is certified Ex ia IIC T4.

Figure 1.1: TXgard-IS+ fitted with toxic sensor

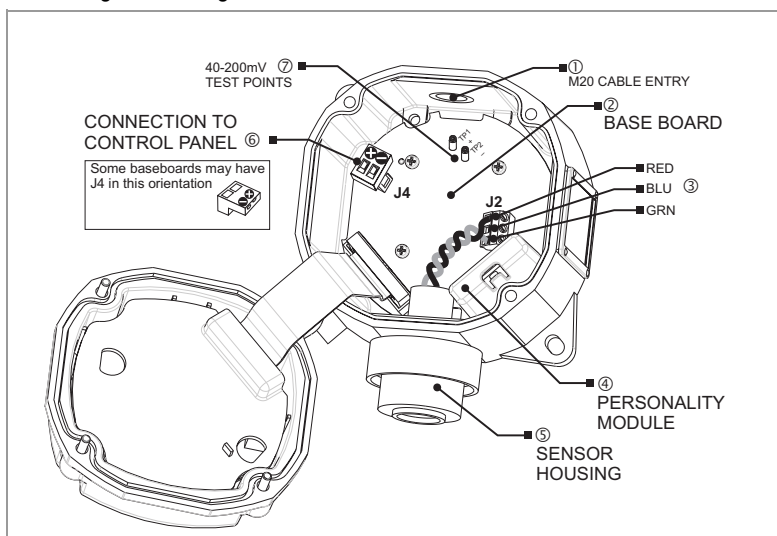

Important

TXgard-IS+ is designed for use in Zone 0, 1 or 2, or Division 1/Division 2 hazardous areas and is certified Ex ia IIC T4 when used with a suitable Zener barrier or galvanic isolator. Installation must be in accordance with the recognised standards of the appropriate authority in the country concerned. TXgard-IS+ should be inspected regularly if used in a dusty environment. For further information, please contact Crowcon.

Before carrying out any installation work, ensure that local regulations and site procedures are followed.

Storage Instructions

The sensor used in this detector has a maximum non-powered storage life of 3 months. Sensors stored within a detector for longer than 3 months prior to commissioning may not last for the full expected operational life. The warranty period for the sensor begins from the date of shipment from Crowcon.

Detectors should be stored in a cool and dry environment where temperatures remain within the 0-20°C range

Txgard-IS+ GAS DETECTOR

» CROWCON
Abingdon, United Kingdom, OX14 1DY

Ui=28V Ii=93mA Pi=0.66W

Ex II 1G **CE 1180**

Ex Ia IIC T4 Ga (-40°C to +65°C)
Baseefa 08ATEX0069X
IECEx BAS08.0028X

Warning: Static Hazard Clean Only with a Damp Cloth

Prog No. 3671-CERT 1882

» CROWCON
TXgard-IS+
GAS DETECTOR
CLASSIFIED FOR INTRINSIC SAFETY
FOR USE IN HAZARDOUS LOCATIONS:
Class I, Division 1, Group A, B, C, & D
-40°C ≤ Tamb ≤ +65°C T4
I_{max} :93mA C_i:0,1nF
V_{max} :28v L_i:10uH P_i:0.66W

CLASSIFIED
UL **us** *Exia*
66Y6

Warning - Substitution of Components May Impair Intrinsic Safety. Understand Manual Before Operating Control Drawing TXISP-3841-A3

TXgardIS+ ATEX, UL and IECEx Intrinsically safe

2 INSTALLATION

2.1 General

The detector should be mounted where the gas is most likely to be present. The following points should be noted when locating gas detectors:

- To detect gases that are lighter than air, detectors should be mounted at high level. Crowcon recommends the use of a Collector Cone (part no. C01051).
- To detect gases that are heavier than air, detectors should be mounted at low level.
- To detect gases with similar weight to air, for example, hydrogen sulphide, mount the detector at normal breathing height.
- When locating detectors, consider the possible damage caused by natural events such as rain or flooding. For detectors mounted outdoors, Crowcon recommends the use of a spray deflector (part no. C01338).
- Mounting of oxygen detectors requires knowledge of the gas displacing the oxygen. For example, carbon dioxide is heavier than air and displaces oxygen at low level. Under these circumstances oxygen detectors should be placed at low level.
- Consider ease of access for functional testing and servicing.
- Consider how the escaping gas may behave due to natural or forced air currents. Mount detectors in ventilation ducts if appropriate.
- Consider the process conditions. Gases that are normally heavier than air, but are released from a process line that is at a high temperature and/or under pressure, may rise rather than fall. Ammonia released from a cooling system may fall rather than rise.

The placement of the sensors should be decided following the advice of experts with specialist knowledge of gas dispersion, experts with knowledge of the process plant system and equipment involved, and safety and engineering personnel. **The agreement reached on the locations of sensors should be recorded.** Crowcon is pleased to assist in the selection and siting of gas detectors.

2.2 Mounting

TXgard-IS+ should be installed at the location with the detector pointing down. This ensures that dust or water will not collect on the sensor and stop gas entering the detector.

Figure 2.1: TXgard-IS+ dimensions

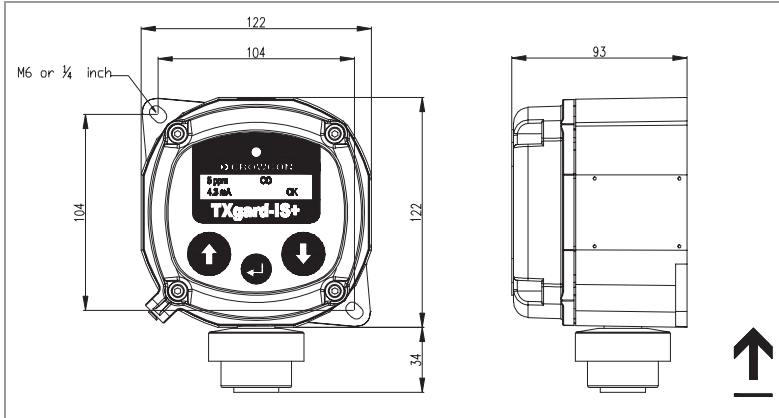

2.3 Cabling requirement

Cabling to TXgard-IS+ must be in accordance with the recognised standards of the appropriate authority in the country concerned, and must also meet the electrical requirements of the detector. Crowcon recommends the use of 2-core twisted pair cable, but there is no particular restriction as long as it can supply 8 V at 20 mA to the instrument terminals. Suitable weatherproof glands must be used. Cable should be identified as being intrinsically safe by some means, for example, by having a blue outer sheath. Alternative cabling techniques, such as steel conduit, may be acceptable provided that appropriate standards are met.

TXgard-IS+ requires a dc supply of 8-32 V and is loop powered. (If mounting in a hazardous area, do not use a higher voltage than the Zener barrier's rating, usually 28 V). Ensure there is a minimum supply of 8 V at the detector, taking into account the voltage drop due to cable resistance and the sense resistance of the control panel to which it is connected. "Table 2.1" on page 10, shows maximum cable distances given typical cable parameters (See **appendix F** for more information).

Table 2.1: Maximum cable distances for typical cables

Cross-sectional area (mm ²)	Typical resistance (Ω per km)		Maximum distance (km)
	Cable	Loop	
1.0	18.1	36.2	2.2
1.5	12.1	24.2	3.3
2.5	7.4	14.8	5.4

The acceptable cross-sectional area of cable used is 1.0 to 2.5 mm².

The table is provided for guidance only. Actual cable parameters for each application should be used to calculate maximum cable distance. Assume each termination is 0.5 Ω.

2.4 Electrical connections

All connections to the 4-20 mA loop, and sensor, are made via the screw terminal connectors mounted on the baseboard in the junction box. "Figure 1.1" on page 6. For further information on how 4-20 mA current loops work, see "Appendix E". For a worked example of how to calculate if the cable is suitable, please see "Appendix F".

"Figure 2.2" below, shows the baseboard in detail. The terminals marked **J4** should be connected to the control equipment using the appropriate **+** and **-** terminals. For further details of wiring the TXgard-IS+ to Crowcon equipment see "Appendix A".

Figure 2.2: Baseboard

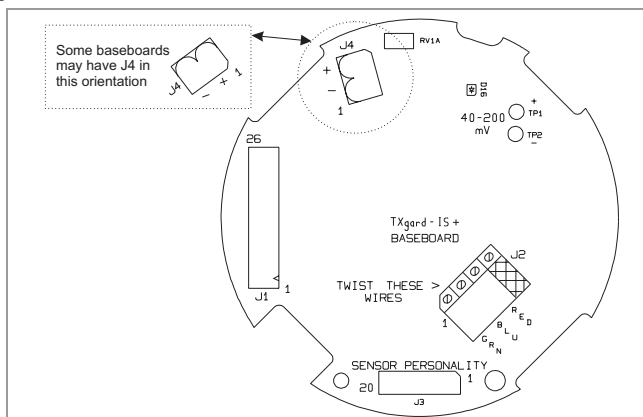

TXgard-IS+ is a 4-20 mA sink, loop-powered device designed to work in safe and hazardous zones 0, 1 and 2 areas when used in conjunction with an appropriate barrier. Figures 2.3, 2.4 and 2.5 summarise the electrical connections.

SAFE AREA

Figure 2.3: Electrical connections for safe area

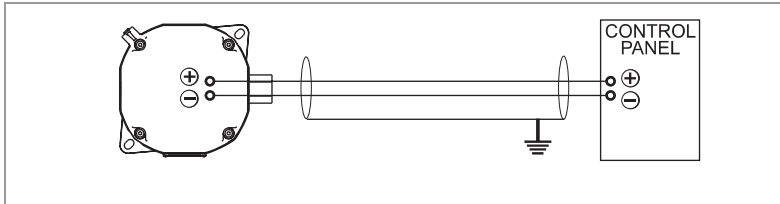

HAZARDOUS AREA

Note: An IS earth connection must be supplied in the safe area, so as to avoid earth loops and to maintain IS certification.

Figure 2.4: Electrical connections using Zener barrier

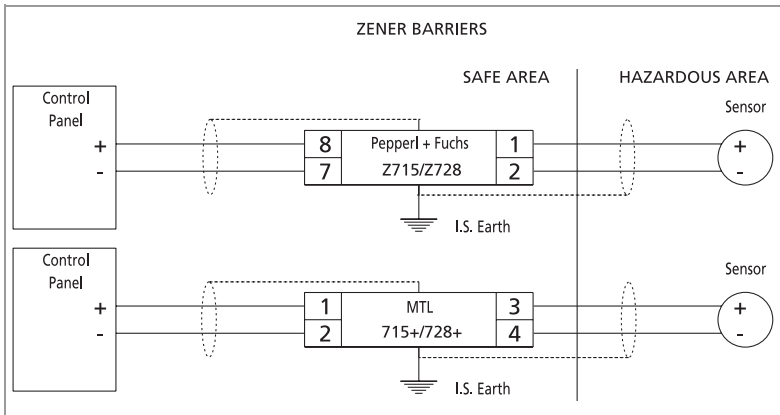
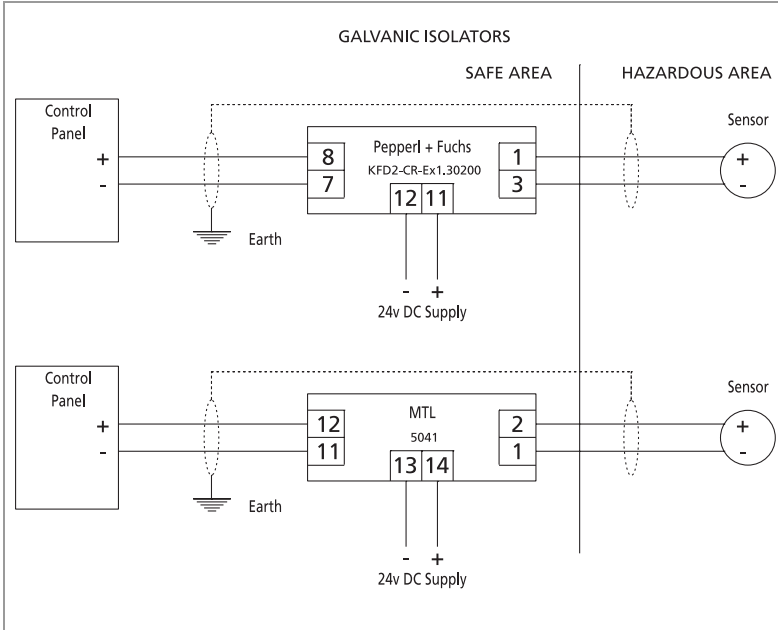

Figure 2.5: Electrical connections using galvanic isolator



3 OPERATION

3.1 The operator display panel and keypad

The TXgard-IS+ provides an operator display panel through a Liquid Crystal Display (See "Figure 3.1"). The operator display panel allows you to communicate with the TXgard-IS+ instrument through a series of text based menus. Use the operator panel to calibrate the sensor, adjust signal levels and resolve instrument errors. You may also display information on serial number, software version and adjusting advanced settings.

The operator display panel provides continual instrument status on the gas being sensed, the gas reading and the loop current value. A flashing 'OK' indicates the system is operational (see "Figure 3.2"). Press the **down** button to display the voltage and temperature ("Figure 3.3" on page 14), this display will automatically return to the main display after a few moments.

Figure 3.1: Operator display panel and keypad

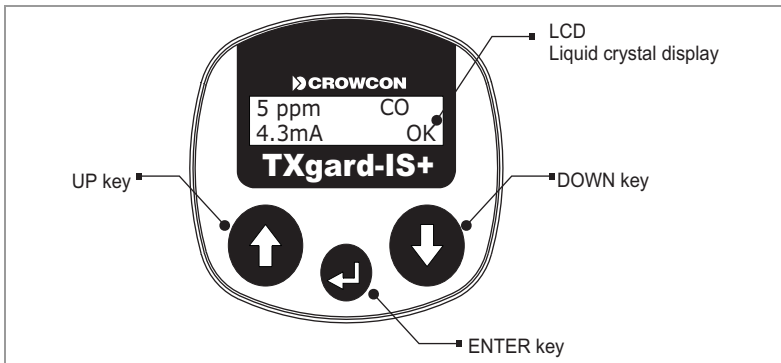

Figure 3.2: LCD 'operator display panel'

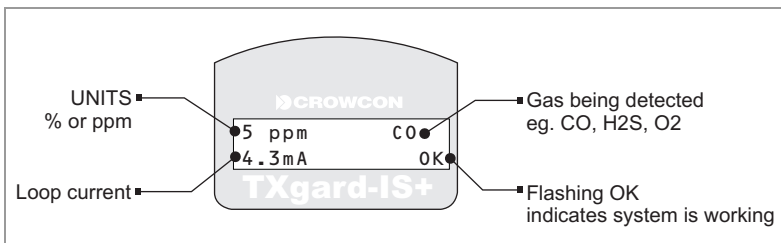
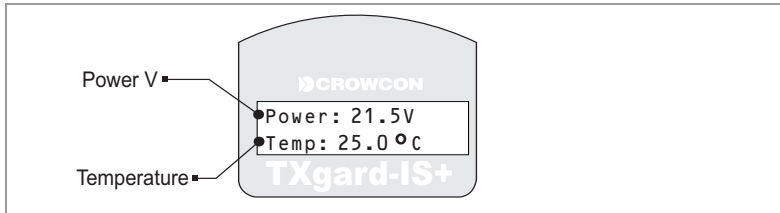

Figure 3.3: Power and temperature display (after pressing DOWN key)



3.2 Using the TXgard-IS+ menus

Three buttons are provided to select the menu options and respond to instrument messages, the **UP** (UP) and **DOWN** (DOWN) button moves your selection through the menu list, a cursor '**>**' indicates current selection. To enter that selection, press the **ENTER** (ENTER) key.

To enter the menu system:

- 1 Press the **DOWN** button and then the default password, which is the **down** button **five** times.
- 2 Press the **DOWN** button again to exit the menu system if you decide not to change the instruments settings.

The operator display panel shows the available menus. The TXgard-IS+ has seven standard menus that allow you to calibrate and configure the instrument. The menu structure for a TXgard-IS+ Toxic detector is shown in "Figure 3.4" on page 14, detailed menus can be found in Appendix D.

NOTE: *the menu for the oxygen detector only varies for the 'Zero/cal gas' menu item which is replaced by 'Cal O2 @ 20.9%'.*

To exit the main menu display

- 1 To exit any menu, use the **UP** key to move the cursor to the **top** of the menu list where you will find **To gas display**. If you are in a submenu you will need to repeat this and move the cursor to the top of the menu list to return to the gas display. **Note: UP = OUT.**

Tip

To go directly to the bottom of a menu, press **DOWN** and **ENTER** simultaneously.

To go directly to the top of a menu, press **UP** and **ENTER** simultaneously.

The menu will also return to the gas display after a timeout (default 5 minutes).

Figure 3.4 Menu structure for TXgard-IS+ toxic detector

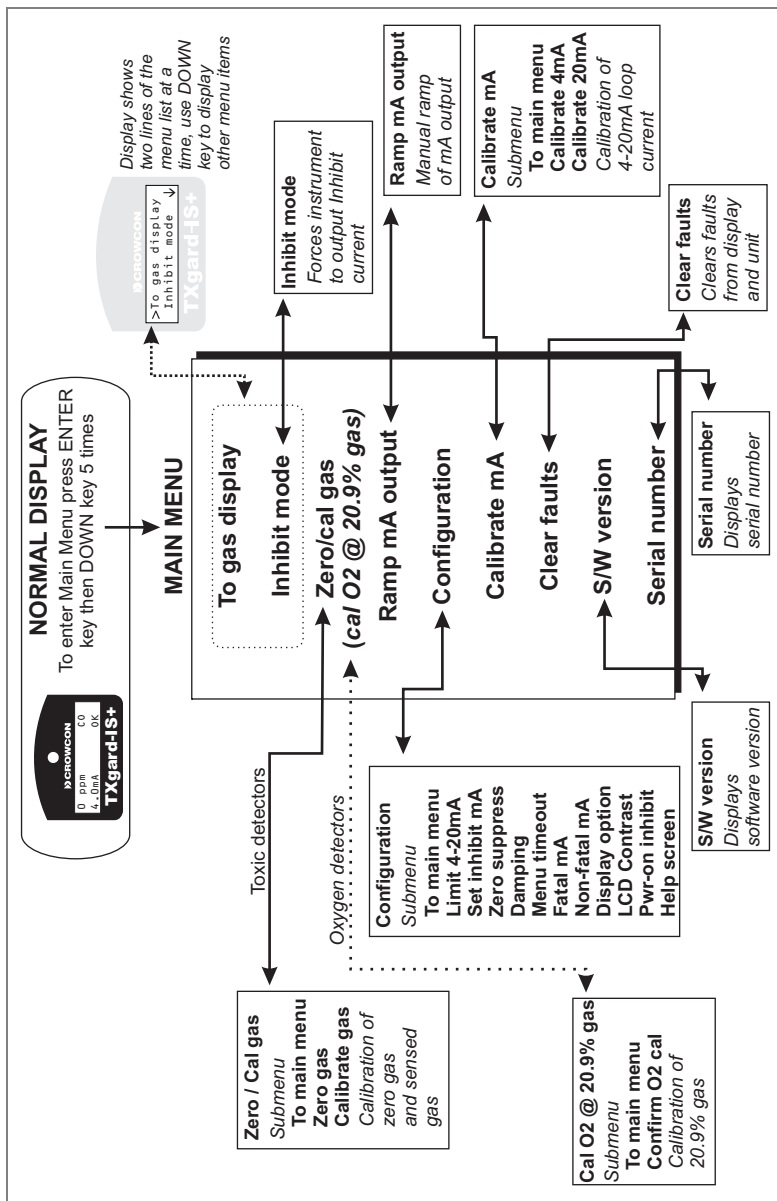

See Appendix D and Section 4.2 for further information.

4 COMMISSIONING

The commissioning procedures for toxic detectors can be found in section 4.1. To commission oxygen detectors go to section 4.2.

Warning

Before carrying out any work, ensure that local regulations and site procedures are followed. Ensure that the associated control panel is inhibited to prevent false alarms.

4.1 Commissioning procedure: Toxic gas detectors

NOTE: To prevent false alarms during calibration, enable *inhibit mode* prior to zeroing or applying gas (see Figure 3.4). The detector output will then remain at the preset inhibit level (see Appendix D) for **five minutes** or until *inhibit mode* is cleared manually. “Inhibit” will appear on the normal operating display when inhibit is active, and the detector will automatically resume gas level output after five minutes.

Step 1:

Connecting the detector to the control panel

- 1 Apply power to the detector via 2-way connector J4. “Figure 1.1” on page 6.

The instrument requires a minimum of 8 V dc at connector J4 at 20 mA.

Tip

As long as the instrument is running, you can see the supply voltage on the display panel, by pushing the  button.

- 2 Leave the detector to stabilise for at least 2 hours.

NOTE: *the detector is factory pre-set to automatically inhibit its mA output for 30 seconds after power-up to prevent false alarms while the sensor is settling.*

Step 2:

Checking the 4-20 mA loop current

This step can be omitted as the TXgard-IS+ is delivered pre-calibrated, however, if you wish to check the 4-20 mA loop

current, then it can be checked as outlined below. Alternatively the TXgard-IS+ provides a facility to force a known current through the loop. Refer to the *Ramp mA* menu item in Appendix D for instructions.

NOTE: *there is no need to disconnect a sensor when calibrating mA! The mA control circuit is completely independent from the gas measuring circuit!*



- 1 Connect a digital voltmeter (DVM) across test points TP1 and TP2 on the baseboard (“Figure 1.1” on page 6 or “Figure 2.2” on page 9). The loop current flows through a sense resistor between these test points, so a 4 mA loop current will show as 40 mV on the DVM, and 20 mA will show as 200 mV.

Step 3:

Zeroing the detector in clean air

Before commencing zeroing the detector, ensure the instrument is in clean air.

NOTE: *Oxygen sensors do not need manual zeroing with the TXgard-IS+. See section 4.2 for calibration instructions.*

- 1 Enter the menu system by pressing the  button.
- 2 At the password prompt enter the password, by default this is the **down** button  **5** times.
- 3 You should now be in the *main menu*. Refer to menu structure, (“Figure 3.4” on page 15).

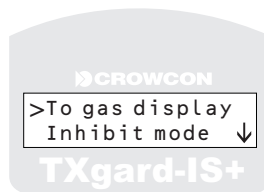

- 4 Move the cursor down and select the *Zero/Cal gas* menu item. The submenu list for zeroing and calibrating the gas appears.
- 5 Select the *Zero gas* menu item. The instrument will display a scrolling text message: ‘Ensure the instrument is in clean air and the sensor has settled’.

- 6 Press the  button to start zeroing the detector.

The instrument will display the following message:

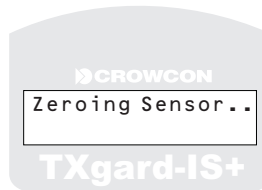

When complete the instrument will report a scrolling text message 'Zero operation successful'.

- 7 Press the  button to continue, the display will return to the *Zero/cal submenu*.

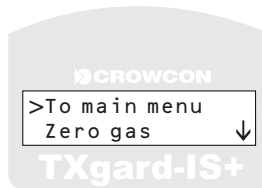

- 8 You may now proceed to calibrate the gas on the detector.



Step 4:

Calibrate gas on the detector

Before commencing calibrating gas on the detector ensure you have sample gas. For Oxygen sensors go to section 4.2.

NOTE: *Whilst in calibrate mode, the instrument outputs the Inhibit current.*

If you have just completed step 3 (Zeroing) you will still be in the *Zero/Cal Gas submenu*, and can skip to 5.

- 1 Enter the menu system by pressing the  button.
- 2 At the password prompt enter the password, by default this is the **down** button  5 times.

- 3 You should now be in the main menu

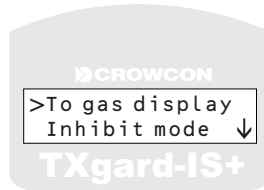

- 4 Select the **Zero/Cal** gas menu. The submenu list for zeroing and calibrating the gas appears.
- 5 Move the cursor down and select the **Calibrate** gas menu item

The panel will display a scrolling text message: 'Apply calibration gas to instrument --'.

- 6 Apply calibration gas (typically half or full scale) to the detector at a flow rate of 0.5 litre/minute. (Crowcon Flow Adaptor part No. C03005)

Tip

Sticky gases which are rapidly absorbed by connecting pipes (chlorine, nitrogen dioxide and ozone) are applied at 1 litre / minute.

- 7 Select the **↵** button.

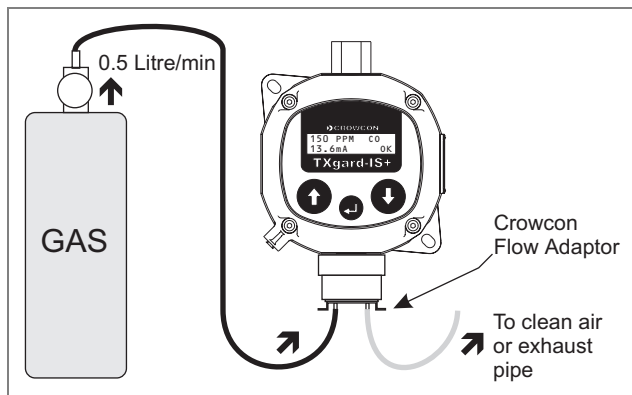

Allow gas reading to stabilise.

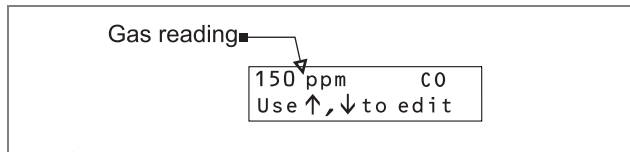

Use **↑** and **↓** buttons to adjust gas reading to calibration gas value.

Gas value is usually measured in ppm or as %vol (ppb and %LEL are also available, as appropriate).

Tip

See "Table 4.1" on page 21 for some gases and their typical range. Please note that detectors can be provided in different ranges if required.

Contact Crowcon for list of all gases detected.

- 8 Select the **↓** button to set the calibration value. The instrument will display the following message:



When complete the instrument will report a scrolling text message: 'Calibration successful! Remove gas from the instrument --'.

- 9 Remove the gas from the detector and exit the menu system.

The instrument is now calibrated.

If the control equipment display requires adjustment, consult the operating manual for the control display equipment.

Table 4.1: Typical gas ranges

Gas Code	Gas	Unit	Standard Ranges [†]
O2	Oxygen	%vol	0-25
CO	Carbon monoxide	ppm	0-250
H2S	Hydrogen sulphide	ppm	0-25
SO2	Sulphur dioxide	ppm	0-10 and 0-100
CL2	Chlorine	ppm	0-5
<i>[†]Note: other ranges are available on request</i>			

4.2 Commissioning procedure: Oxygen detector

Step 1:

Connecting the detector to the control panel

- 1 Apply power to the detector via 2-way connector J4.
“Figure 1.1” on page 6

The instrument requires a minimum of 8 V dc at connector J4 at 20 mA.

Tip

As long as the instrument is running, you can see the supply voltage on the LCD, by pushing the  button.

- 2 Leave the detector to stabilise for at least 2 hours.

Step 2:

Checking the 4-20 mA loop current

This step can be omitted as the TXgard-IS+ is delivered pre-calibrated, however, if you wish to check the 4-20 mA loop current, then it can be checked as outlined below. Alternately the TXgard-IS+ provides a facility to force a known current through the loop. Refer to the *Ramp mA* menu item in Appendix D for instructions.



NOTE: *there is no need to disconnect a sensor when calibrating mA! The mA control circuit is completely independent from the gas measuring circuit!*

- 1 Connect a digital voltmeter (DVM) across test points TP1 and TP2 on the baseboard (“Figure 1.1” on page 6 or “Figure 2.2” on page 9). The loop current flows through a sense resistor between these test points, so a 4 mA loop current will show as 40 mV on the DVM, and 20 mA will show as 200 mV.

Step 3:

Calibrate Oxygen

NOTE: *Unlike previous models it is not necessary to manually “Zero” Oxygen units.*

- 1 Enter the menu system by pressing the  button.
- 2 At the password prompt enter the password, by default this is the down button  5 times.
- 3 You should now be in the main menu

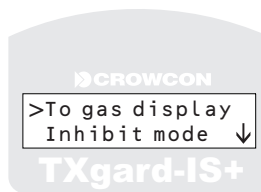

- 4 Move cursor down and select the Cal O2 @ 20.9% gas menu. The submenu list for calibrating oxygen appears.
- 5 Select the Confirm O2 cal menu item. The instrument will display a scrolling text message: 'Ensure the instrument is in clean air and the sensor has settled'.

- 6 Press the  button to start calibrating the detector.

The instrument will display the following message:



When complete the instrument will report a scrolling text message: 'Calibration successful'

- 7 Press the  button to continue and exit the menu system.

The instrument is now calibrated.

If the control equipment display requires adjustment, consult the operating manual for the equipment.

5 MAINTENANCE

Repair of instruments: it is a condition of Certification that damaged instruments may only be repaired by trained personnel. Whilst replacement of sensors or personality modules is permitted by untrained personnel, board-level repairs must be carried out at main Crowcon offices, which are listed on our website at www.crowcon.com.

5.1 Routine maintenance

The operational life of the sensors depends on the application, frequency and amount of gas being seen. Under normal conditions (6-monthly calibration with periodic exposure to test gas) the life expectancy of the toxic sensors is 2-3 years, and 2 years for the oxygen sensors.

Site practices will dictate the frequency with which detectors are tested. Crowcon recommends that detectors be gas tested every month and recalibrated every six months. To recalibrate a detector, follow the steps in Section 4.1 (for a toxic gas detector) or Section 4.2 (for an oxygen detector).

In dusty environments, the detector should be tested more frequently to ensure that the sensor does not become blocked.

There is no need to recalibrate mA.

5.2 Sensor replacement and servicing of detectors

To prevent spurious alarms whilst changing sensors, either -

- put the control system into **Inhibit** mode for this channel (preferred), or
- put the TXgard-IS+ into **Inhibit mode** (See Appendix D), or
- put the TXgard-IS+ into **Ramp mA** mode to hold its output at 4 mA or 17.4 mA, as appropriate (typical ungasged toxic / oxygen "safe" signals).

NOTE: *Ramp mA or Instrument Inhibit modes might time out before the sensor settles, so inhibiting at the control panel end is preferable.*

5.2.1 Detectors with bayonet type sensor housings

NOTE: *There is no need to open the main body of the instrument to replace these sensors.*

1. Open the sensor housing by pushing in and turning simultaneously to release the bayonet fitting and expose the sensor.
2. Remove the sensor from the sensor housing.
3. Fit the replacement sensor, checking the part number is correct. This part number is labelled on the main body of the detector. Observe the correct pin alignment with the PCB.
4. Reassemble the sensor housing.
5. The sensor should now be re-zeroed and calibrated.
See “Commissioning” on page 16. For Oxygen sensors see “Commissioning procedure: Oxygen detector” on page 21).

6 FAULT FINDING

Fatal errors are severe enough that the gas reading cannot be trusted but can sometimes be cleared by removing power and reconnecting it. **Non Fatal** errors are simply warnings that the instrument has noticed a problem, but can continue / recover by using backup data.

Symptom / error message	Cause	Solution
Nothing is displayed - instrument appears dead	The cause is usually no power, ie the wires are the wrong way round.	Reverse the polarity by swapping the wires over. Check supply voltage.
4-20 mA signal is frozen	Instrument outputs a Fault signal Instrument outputs an inhibit current	Examine display to determine fault and take action as described below. <i>Note:</i> the Fault/inhibit currents can be set to 2, 3, 4, 24 mA or Gas Level in the Configuration menu (see Appendix D) Instrument is in calibrate mode. Complete the calibration operation.
“Supply V High” “Supply V Low”	The voltage on the 4-20 mA line is too high (>32 V) or too low (<8 V) for reliable operation.	Adjust power supply. <i>Note:</i> some long cables have significant resistance, and can supply 8 V at the instrument terminals at 4 mA, but not 20 mA. Use the Ramp mA function to confirm line voltage is OK at 20 mA. (See appendix D)

Symptom / error message	Cause	Solution
<p>"Temp. low err." "Temp. high err"</p>	<p>The temperature is too low or high for the instrument to work reliably.</p>	<p>Ensure temperature is between – 20°C and +55°C (–4°F to 131°F). <i>Note:</i> Some sensor types do not work over this entire range.</p>
<p>"Zero warning"</p>	<p>The last zero operation did not succeed – there would have been a scrolling message on completion of the zero operation giving an error whilst still in the menus</p>	<p>Re-zero sensor. Check sensor is in clean air and has settled.</p>
<p>"Cal. warning"</p>	<p>The last calibration operation did not complete successfully – there would also have been a scrolling message on completion of the calibrate stating that the operation had failed.</p>	<p>Recalibrate the sensor: Check the calibration gas is at an appropriate concentration and is applied to the sensor at the correct flow rate 0.5-1.0 litres/minute. Sensors have a finite lifetime: their output gradually decays and eventually they need replacing. Occasionally, sensors die completely, but this normally requires serious abuse (e.g. extreme heat, or very high overloads of gas). Replace sensor.</p>

Symptom / error message	Cause	Solution
"Cal gain error"	The signal is very high or low for the level of gas you are applying. A scrolling message would have been displayed on completion of the zero or calibrate operation giving this fault.	Check you are using the right level of gas, and that you are inputting the correct number through the keypad. Ensure sensor has been properly zeroed before calibrating.
"Gas calib. err" (Fatal)	Gas calibration data stored in the sensor module's non-volatile memory has been corrupted.	Sensor must be re-zeroed and calibrated. Without calibration data the instrument cannot correctly measure gas.
"mA Calib error"	mA calibration data stored in the instrument's non-volatile memory has been corrupted.	mA calibration must be checked, using the Ramp mA function (see Appendix D), and re-calibrated or instrument must be returned to Crowcon for service.
"FRAM1 fault" "FRAM2 fault"	FRAMs are non volatile memory. The instrument has detected corruption in one. FRAM1 is on the main PCB and stores the instrument configuration. FRAM2 is in the Personality Module and stores sensor data (Calibration constants, gas name etc.).	Disconnect power and reconnect it. The FRAM with an error should restore its data from backup in the other FRAM. Alternatively, use the Clear Faults menu option (see appendix D).

Symptom / error message	Cause	Solution
<p>"mA low error"</p> <p>"mA high error"</p>	<p>The instrument is recalibrating its 4-20 mA signal, because it has detected a discrepancy between what it should be and what it is. This could be a result of earth loop currents, for example.</p>	<p>The instrument should finish correcting the mA signal after a few minutes. It is deliberately slow to prevent transient events giving problems. If the problem persists, use the Ramp mA menu item to confirm the instrument is drawing the current it thinks it is (see "Appendix D"). The 4-20 mA signal can be recalibrated if necessary. If there is still a problem, check the cable for ground loops or earthing problems.</p>
<p>"Amplifier error" (Fatal)</p>		<p>Personality module has failed and needs replacing</p>
<p>"Sensor Fault" (Fatal)</p>		<p>Check connections to sensor have not come loose or have been incorrectly wired ("Figure 1.1" on page 6)</p> <p>Alternatively: the instrument cannot see the sensor. If a worn out sensor has just been replaced, confirm that a new one has been placed correctly in the sensor housing.</p>

Symptom / error message	Cause	Solution
mA is unexpectedly low for gas reading	The instrument gas calibration is not set to the correct scale, for example, expected range is 0-25 ppm, range may be set at 0-50 ppm	Recalibrate instrument.
The sample gas is half scale		Check the full scale reading required for example, 0-50 ppm, and the sample gas value, for example, gas is supplied as 25 ppm
Unstable mA or gas reading		Re-zero and re-calibrate instrument
Calibration is difficult whilst applying gas, numbers alter too fast when using up and down arrows	Personality module contains data for different unit	Re-zero and re-calibrate. You may need to perform this procedure twice to reach a stable reading
Display contrast poor	Wrong contrast setting	Check and reconfigure contrast setting in Configuration menu
Display blank/cannot be read at any angle	Faulty circuit, LCD or extremely poor contrast setting	Send to Crowcon for reconfiguration

Error and Fault messages will remain on the operator display panel until they are cleared. Selecting **CLear** **Faults** from the menu will remove them. However, if the fault re-occurs the fault message will be displayed again. Fault current can be configured to be different for Fatal / Non Fatal events, see Appendix D.

APPENDIX A

WIRING THE TXGARD-IS+ TO CROWCON CONTROL EQUIPMENT

This appendix describes how to connect the TXgard-IS+ to the following Crowcon control panels: Vortex, Gasmonitor, Gasmaster and Gasflag. The instructions for connecting the cards and setting the links are outlined below. Connection details for the Ditech range of control equipment will be included on the wiring diagrams supplied for the system.

Connecting the TXgard-IS+ to a Crowcon Vortex

The TXgard-IS + is connected to the Vortex control panel using a **Quad Channel Module**, see “Figure A.1”. The module consists of four channels, each with a 3-way connector. The detector may be connected to any of the four channels shown in “Figure A.1”.

Figure A.1: Quad Channel Module

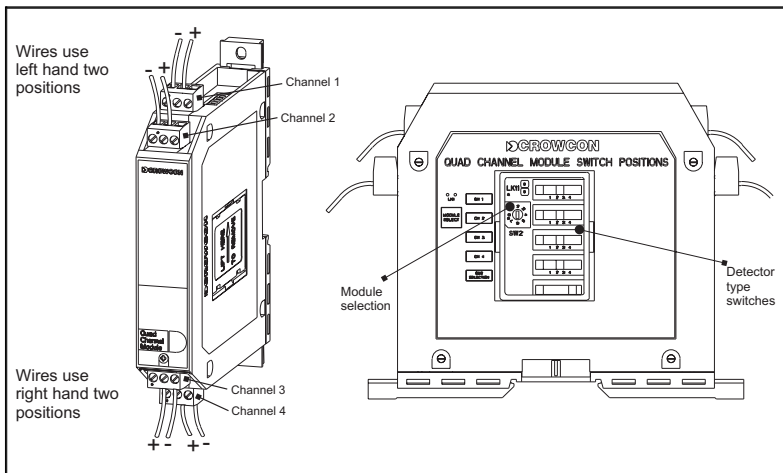

NOTE: *Vortex has certain current levels hard-wired as signals. However, TXgard-IS+ is highly configurable and can be programmed to work with most control panels. When connecting to a Vortex, set the TXgard-IS+ as follows:*
Fatal and Non Fatal Fault Currents = "3 mA"
Inhibit current = "24 mA" or "Clean air level".
The latter is better for long cable runs (less IxR drop).

Set the Detector Type Switch for the appropriate channel to position **2**. The switch can be found in the hatch on the side of the Quad Channel Module, see "Figure A.1".

Connecting the TXgard-IS+ to a Crowcon Gasmonitor

The TXgard-IS+ is connected to the Gasmonitor control panel via an **INPUT/OUTPUT MODULE** at the rear of the Gasmonitor racking system. The links for Toxic and Oxygen detectors are the same, configure the **INPUT card** as follows:

LINK Make these connections

LK1	A, C
LK2	E, I, K
LK3	none
LK4	"4-20"
LK5	"24V"
LK6	"C/C"
LK7	"24V"

At the rear of the Gasmonitor, connect the instrument to the INPUT/OUTPUT MODULE, the section labelled **DETECTING HEADS** (See "Figure A.2"). Choose the channel matching the input card.

The module consists of three rows of 16 channels, the terminals to use are marked 60-107. The top row (terminals 50-55) is not used with the TXgard-IS+. The second row provides 24 V, the third row provides 0 V. The first two terminal blocks are reserved. The remaining 16 channels marked 1-16 can be used to connect the TXgard-IS+, for example, to connect channel 2, connect the positive wire to terminal 64 and the negative wire to terminal 63. "Figure A.2" shows a TXgard-IS+ connected to channel 2.

NOTE: *Gasmonitors will only recognise a 24 mA signal from TXgard-IS+ as Fault. Although Gasmonitors can also be configured to use "less than 2mA" as a Fault signal, the minimum current that the TXgard-IS+ can draw is 2.2 mA, so TXgard-IS+ will not trigger Gasmonitor's Fault if the TXgard-IS+ Fault signal is set to 'minimum' (2.2 mA).*

Figure A.2: Electrical connections for Gasmonitor

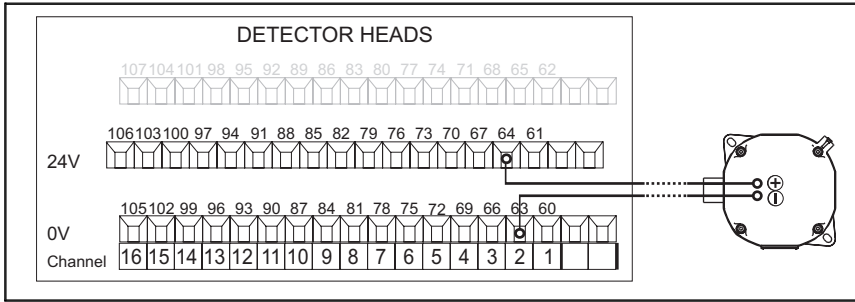

Connecting the TXgard-IS+ to a Crowcon Gasmaster

The TXgard-IS+ is connected to a Gasmaster control panel as shown below. The Gasmaster input channel link should be set to 'SINK' and the input channel should be configured as 'DET 4-20 SINK'. For hazardous area installations refer to the Gasmaster manual.

Figure A.3: Electrical connections for Gasmaster

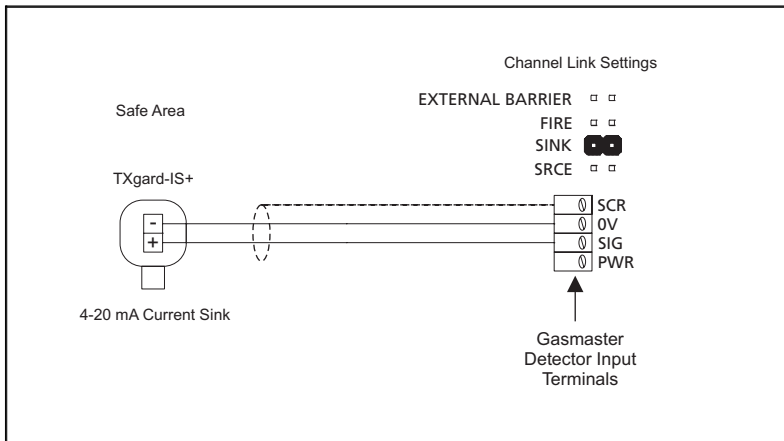

Connecting the TXgard-IS+ to a Crowcon Gasflag

The TXgard-IS+ is connected to the Gasflag via the screw terminals marked SENSOR +VE (this is the TXgard-IS+ positive supply) and SENSOR SIG (which connects to TXgard-IS+ negative supply). Set links LK10A and LK10B to SOURCE, position B.

Figure A.4: Electrical connections for GasFlag

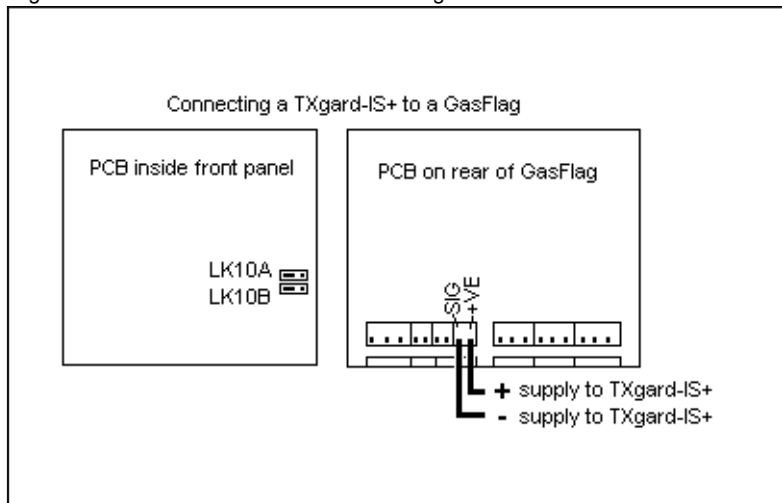

APPENDIX B

TXGARD-IS+ SPECIFICATION

Dimensions	160 x 123 x 92 mm (7.3 x 5 x 3.6 inches)
Weight	700 g
Operating voltage	8-32 V dc, loop-powered, 4-20 mA
Normal Output Signal	4-20 mA current sink
Fault current	Minimum, 3 mA, 24 mA, or normal gas signal (configurable)
Operating temperature	<p>−40°C to +65°C (−40°F to 149°F)</p> <p><i>Note: Instrument operates and has been certified as Intrinsically Safe between −40°C and +65°C, giving out a 4-20 mA signal proportional to measured gas; but LCD will go blank at about −20°C. The sensor's performance changes at extremes of temperature; consult Crowcon if the detector will be exposed to ambient temperatures below −20°C or above +40°C</i></p>
Humidity	15-90% RH, non-condensing for most sensors
Display	2 x 16 character LCD
Response time (typical)	(T ₉₀): approximately 20 seconds for most Toxic sensors, 10 seconds for Oxygen*
Repeatability	±2% FSD, 6 months*
Cable loop resistance	300 Ω with 22 V supply at 20 mA
Degree of protection	IP65 (when fitted with Weatherproof Cap)
Explosion protection	Intrinsically Safe
Approval codes	<p>Ⓔ II 1G Ex ia IIC T4(−40°C to +65°)</p> <p>UL/cUL: CI I, Div 1 Groups A,B,C,D</p>
Safety certification nos.	<p>Baseefa 08 ATEX 0069X, UL E147777</p> <p>IECEX BAS 08.0028X</p> <p>"X" Special Conditions for Safe Use: Warning: Static Hazard Clean Only with a Damp Cloth.</p>

Standards	<p>EN60079-0 (safety in flammable atmospheres) EN60079-11 (intrinsic safety) EN50022 (emissions) IEC61000-4 (immunity) EN50270 (EMC for gas detection equipment) EN50271 (software design standard) UL (UL913 Ed 7) cUL (CSAC22.2 No.157) class 1 group A,B,C and D</p> <p>This device complies with part 15 of the FCC Rules. Operation is subject to the following two conditions: (1) This device may not cause harmful interference, and (2) this device must accept any interference received, including interference that may cause undesired operation.</p> <p>This Class A digital apparatus complies with Canadian ICES-003.</p> <p>Cet appareil numérique de la classe A est conforme à la norme NMB-003 du Canada.</p>
Zones	<p>ATEX/IECEX: 0, 1 & 2</p> <p>UL: Class 1</p>
Gas groups	<p>ATEX/ IECEX: IIC</p> <p>UL: A,B,C & D</p>
Zener barriers or galvanic isolators	<p>Max 28 V; 93 mA 0.66 Watts</p>

*Specifications are typical, and may vary for different sensor types.

APPENDIX C

SPARE PARTS AND ACCESSORIES

Please contact Crowcon for details of the latest replacement sensors. Please quote the part number given on the "Sensor Replacement label" mounted on the outside of the sensor housing.

Description	Part Number
M20 to ½" NPTF adaptor	M02125
M20 to ¾" NPTF adaptor	M02281
Ceiling mounting bracket	M01401
Collector cone	C01051
Spray deflector	C01338
728 Zener barrier for use with 24 V dc systems	C03221
5041 Galvanic isolator	C03278
Mounting box for 2 Zener barriers	C03224
Mounting box for 5 Zener barriers	C03225
Mounting box for 12 Zener barriers	C03226
Mounting box for 4 galvanic isolators	C01560
Mounting box for 8 galvanic isolators	C01561
Calibration gas	Contact Crowcon
Bayonet sensor housing 3-wire	S01343
Bayonet sensor housing 2-wire (oxygen sensor)	S012027

APPENDIX D



MENU SYSTEM

This section provides greater details for the TXgard-IS+ menu items and is a supplement to the section “Using the TXgard-IS+ menus” on page 14. You may wish to refer to the Menu Map on the back cover to familiarise yourself with the menu hierarchy.

This appendix also works in conjunction with the Fault Finding guide on page 26.

To enter the TXgard-IS+ Menu System

Press the  button and then the default password which is the **down** button **five** times.



To select a menu item use the UP  and DOWN  buttons to move the cursor ‘>’ to the desired menu item and press the  button.

Inhibit mode

Description: Forces instrument to output the Inhibit current.

This menu option provides a convenient option to allow an engineer to force the instrument to output the Inhibit current whilst he carries out maintenance on the TXgard-IS+. This will prevent unwanted alarms being seen at the control panel whilst, for example, the sensor is changed. It provides an alternative to setting the instrument into Calibrate mode which also outputs the Inhibit current.

Instructions

1. Enter the TXgard-IS+ menu system by pressing the  key followed by the **down** key  **five** times.
2. Move the cursor down and select the `Inhibit mode` menu item. By selecting *Enable Inhibit* mode the detector output will be forced to a level set in the `Set Inhibit mA` menu. “Inhibit” will then be shown on the normal gas level display. Inhibit mode will time-out after five minutes, or can be manually reset using the *inhibit mode* option.

The display should look as follows;



Gas Calibration Menus

Description: The gas calibration menus provide the instructions and means to calibrate the instrument. This menu is different for toxic detectors and oxygen detectors.

The Toxic detector has two menu items, one to zero the unit and the other to set the calibration gas level. The oxygen detector has only one menu item to set the oxygen level. It is **not required** to manually zero an oxygen detector.

See Sections 4.1 and 4.2 for detailed step-by-step instructions for using these menus.

Menu: (Toxic detectors)

Zero/Cal gas

Submenu

To main menu

Zero gas

Calibrate gas

Zero gas

This menu provides instructional guidelines to zero an instrument.

Calibrate gas

This menu provides instructional guidelines to calibrate the gas on the instrument.

Menu: (Oxygen detectors)

Cal O2 @ 20.9% gas

Submenu

To main menu

Confirm O2 cal

Cal O2 @ 20.9% gas

This menu provides instructional guidelines to set the oxygen level on an oxygen detector. *Note:* clean air is always considered to be 20.9% oxygen.

Ramp mA output

Description: This menu item allows you to **force the output loop current to a known value**. It does not calibrate the 4-20 mA loop current or affect any calibration values within the TXgard-IS+ detector.

The TXgard-IS+ provides convenient test points within the instrument to measure the loop current. The test points TP1 and TP2 can be found on the baseboard ("Figure 1.1" on page 6 and "Figure 2.2" on page 10). The loop current flows through a sense resistor between these test points, so a 4 mA loop current will show as 40 mV on the DVM, and 20 mA will show as 200 mV.



When would I use it?

Ramp mA output can be used **to help calibrate and set up the control panel used with a TXgard-IS+ detector** by forcing a known current through the loop. It is also useful for locking the output to a known level which will not trigger alarms whilst, for example, changing the sensor.

It is also useful if you suspect the current is no longer calibrated. In this case it can be checked at test points TP1 and TP2.

It is useful during installation to force the loop current to the maximum value (20 or 24 mA, depending on configuration). The installer can then confirm line voltage is at least 8 V at the instrument terminals at maximum current, even with maximum voltage drops in the loop.

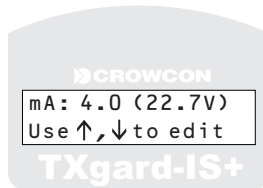

Instructions

1. Enter the TXgard-IS+ menu system by pressing the  key followed by the **down** key  **five** times.
2. Move the cursor down and select the Ramp mA output menu item by pressing . The display should look as follows;



NOTE: *The display shows the loop current and the voltage on the 4-20 mA line at the detector. The voltage will fall as the instrument takes more current due to the voltage drops in the Zener barrier and*

cable. The voltage must remain greater than 8 V at the instrument terminals for the instrument to function.

3. Use the UP  and DOWN  keys to adjust the loop current value. The current value will increment in 0.5 mA steps. The default value of the loop current when the menu is first entered is 4 mA. The loop current can be forced to 24 mA or reduced to 3.5, 3.0 and Minimum output. Press the  key when finished.

NOTE: *on oxygen detectors, a signal of 4 mA is likely to generate a low oxygen alarm at the control equipment.*

4. Exit the menu system.

Configuration

The TXgard-IS+ detector provides a configuration menu to set various options. Below is a list of options, the values that can be set and a description.



Menu:

Configuration

Submenu

To main menu
Limit 4-20 mA
Set inhibit mA
Zero suppress
Damping
Menu timeout
Fatal mA
Non-fatal mA
Display option
LCD Contrast
Pwr-on inhibit
Help screen

Menu item	Options	Description
To Main Menu	Exit	Exit to main menu.
Limit 4-20 mA	Enable / Disable	If enabled, the instrument will only ever draw a maximum of 20 mA, no matter what the gas value.
Set inhibit mA	Minimum, 3 mA, Clean Air mA, or Gas Level	When the instrument is in inhibit mode or calibration mode, the instrument outputs an inhibit current to prevent false alarms whilst gas is applied. When inhibit current value is set to 'Gas Level' the loop current is not inhibited.
Zero suppress	None, Minor or Major	Defines the size of the dead band about the zero point of the device. This will suppress unwanted spurious signals and improve stability at zero. Suppression may be set to 3 levels, with increasing levels of suppression.
Damping	None, Light, Medium or Heavy	Damping is the means where noisy gas readings may be smoothed out. However, increasing the amount of damping in order to reduce the amount of noise will be at the expense of sensor response time.
Menu timeout	30 secs, 1, 5 or 10 minutes/ No timeout	This sets the timeout value before a menu display will automatically return to the normal display mode if there is no response or input from the user. 'No timeout' will disable the timeout option.
Fatal mA	Minimum, 3 mA, 24 mA or Gas Level	This selects the current the instrument will sink when a fatal error has been detected. <i>Note:</i> the option 'gas level' is available; this means the instrument will ignore the error for the purposes of loop current - a display message will still flash as normal.

Menu item	Options	Description
Fatal mA	Minimum, 3 mA, 24 mA or Gas Level	This selects the current the instrument will sink when a fatal error has been detected. <i>Note:</i> the option 'gas level' is available; this means the instrument will ignore the error for the purposes of loop current - a display message will still flash as normal.
Non-fatal mA	Minimum, 3 mA, 24 mA or Gas Level	This selects the current the instrument will sink when a non fatal error has been detected. <i>Note:</i> the option 'gas level' is available; this means the instrument will ignore the error for the purposes of loop current - a display message will still flash as normal.
Display option	No display, Normal display, mA display,	This selects what information is displayed on the normal gas display screen. 'Normal' means the gas level and flashing 'OK' is displayed, 'mA display' also displays the loop current and 'no display' suppresses all information.
LCD Contrast	Contrast adjustment	Pressing the up and down arrows will increase and decrease the display's contrast. Pressing RETURN [copy in symbol from cell above] will return to last menu.
Pwr-on inhibit	Enable / disable	Selects whether the detector output is automatically inhibited for 30 seconds after power-up. The output current level while in inhibit mode is set using the <i>Set Inhibit mA</i> menu.
Help screen	Enable / disable	If further help is enabled, the menu will display more detailed help messages. The user will be presented with "For error help press  , else RETURN  ", if a warning message is displayed.

Calibrate mA

Description: The Calibrate mA menu provides a means of re-calibrating the 4-20 mA loop current.

NOTE: *The TXgard-IS+ detectors leave the factory with the 4-20 mA signal correctly calibrated. This menu is provided for Service Engineers to adjust the calibration to match site control equipment which cannot itself be correctly calibrated.*

Menu:

Calibrate mA
Submenu
To main menu
Calibrate 4 mA
Calibrate 20 mA

Instructions

The TXgard-IS+ detector provides two test points to measure the signal current. Connect a Digital Volt Meter (DVM) across the test points TP1 and TP2. ("Figure 2.2" on page 10.) The loop current flows through a sense resistor between these test points, so a 4 mA loop current will show as 40 mV on the DVM, and 20 mA will show as 200 mV.

1. Enter the TXgard-IS+ menu system by pressing the **↵** key followed by the **down** key **↓** **five** times.
2. Move the cursor down and select the `Calibrate mA` menu item. You are now in the Calibrate mA submenu.
3. Move the cursor down and select the `Calibrate 4 mA` menu item. The display should look as follows;



4. Use the UP **↑** and DOWN **↓** keys to adjust the voltage reading on the DVM as required across the test points TP1 and TP2 (nominally 40 mV). Press the **↵** key when finished.

5. To calibrate the 20 mA, select the `Calibrate 20mA` menu item and repeat step 4 adjusting the voltage reading to 20 mA value (nominally 200 mV). Press the  key when finished.
6. Exit the menu system.

Clear Faults

Description: Clears Faults from display and unit.

When the TXgard-IS+ detects a fault, a warning message will be displayed on the operator display panel. Refer to the Fault Finding guide on page 26 to determine cause and solution to the fault.

For example, if an instrument detects the line voltage dropping below 8 V, it will flash the warning: *Supply voltage low* even if the supply voltage recovers, to warn you that there was a problem with the supply.

To clear a warning message from the TXgard-IS+ detector

To clear the warning message, enter the TXgard-IS+ menu system, move the cursor down and select `Clear faults` menu item and press the  key.

NOTE: *Error and Fault messages will remain on the operator display panel until they are cleared. Selecting Clear Faults from the menu will remove them, however, if the fault re-occurs the fault message will be displayed again*

S/W version

Description: this menu item displays the software version of the detector.

Serial number

Description: this menu item displays the serial number of the detector.

APPENDIX E

4-20 mA LOOPS

A 4-20 mA loop is a standard method of connecting remote instruments to a control panel.

The basic concept is that a reading of zero gas corresponds to 4 mA, and full scale gas corresponds to 20 mA.

The control panel supplies typically 24 volts down 2 wires, and measures the current flowing in the loop. The remote instrument, in this case a gas detector, controls the current:

The constant 4 mA is used to run the instrument processor, amplifier etc. This is termed a **loop powered, current sink circuit**. In this case, the control equipment is providing (or sourcing) the current and the detector is receiving (or sinking) the current. The detector is consequently termed a current sink and the control equipment must be configured to act as a current source.

Figure E.1

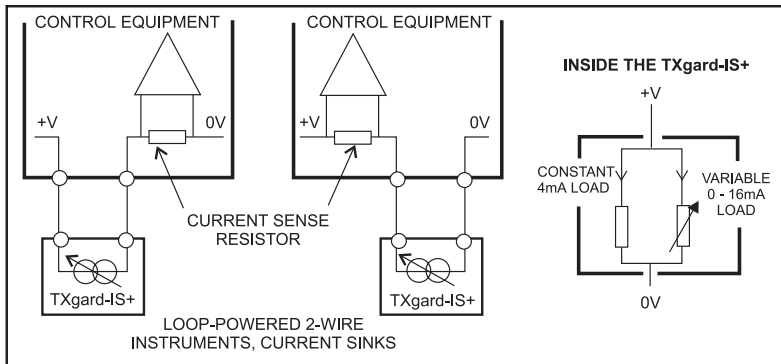

Current loops are often more resistant to radio frequency interference than a simple voltage reading, and they will generally work down long cables (e.g. over a kilometre). When using current loops, care must be taken that the voltage drop of the maximum signal (usually 20 mA) down the line does not reduce the line voltage below 8 V, which is the minimum working voltage of the TXgard-IS+. See section 2.3 for further information on cabling requirements.

NOTE: *It is also possible to have 3-wire current loops. In this case, the instrument is powered by one pair of wires (+ supply and 0 V) and the*

*current signal is measured between the third wire and 0V. Because 3-wire circuits don't depend on the current in the signal loop to power them, they can also **source** current. However, they require more expensive Zener barriers to make them intrinsically safe, and cannot be retrofitted into existing 2-wire installations without replacing the cabling.*

APPENDIX F

CABLING REQUIREMENT

Cabling to TXgard-IS+ must be in accordance with the recognised standards of the appropriate authority in the country concerned, and must also meet the electrical requirements of the detector. Crowcon recommends the use of 2-core twisted pair cable, but there is no particular restriction as long as it can supply 8 V at 20 mA to the instrument. Suitable weatherproof glands must be used. Cable should be identified as being intrinsically safe by some means, for example, by having a blue sheath. Alternative cabling techniques, such as steel conduit, may be acceptable provided that appropriate standards are met.

TXgard-IS+ requires a dc supply of 8-32 V and is loop powered. (If mounting in a hazardous area, do not use a higher voltage than the Zener barrier's rating, usually 28 V). Ensure there is a minimum supply of 8 V at the detector, taking into account the voltage drop due to cable resistance and the sense resistance of the control panel to which it is connected.

For example, a nominal dc supply at the control panel of 24 V has a guaranteed minimum supply of 18 V. The circuit may demand up to 24 mA (see note 1). Given a sense resistor in the control panel of 250 Ω (dropping 6 V at 24 mA) the maximum voltage drop allowed due to cable resistance is 18-8-6 = 4 V. Thus the maximum loop resistance allowed is 4 V/24 mA = 166 Ω (approximately).

Safe installation (only relevant for installations in Hazardous Areas):

TXgard-IS+ depends on the principle of Intrinsic Safety to prevent explosions. This means that the energy stored in the instrument never reaches a level which could cause a dangerous spark capable of igniting gas. Since some energy is stored in the cable, the installation must consider the safety of the entire system: Barrier + Cable + Instrument. Fortunately, the calculations are quite straightforward.

Connection to the safe area is via a zener barrier or galvanic isolator. The barrier or isolator will have a maximum permissible set of L, C and perhaps L/R values printed on it. **Example:**

MTL type 728 barrier

$V_{oc} \leq 28.12 \text{ V}$, $I_{sc} \leq 93 \text{ mA}$, $C_a \leq 0.083 \text{ uF}$, $L_a \leq 3.05 \text{ mH}$

This means that the barrier output will not exceed 28.12 V or 93 mA into the Hazardous Area, due to the barriers' internal clamps and fuse. At these power levels, you can attach up to 0.083 microfarads of capacitance and 3.05 millihenries of inductance and still be safe.

Example: *unsafe:* a 1 microfarad load would store enough energy ($0.5 \times C \times V^2$) to potentially cause a spark capable of igniting gas.

TXgard-IS+ has been designed to have as low a capacitance and inductance as possible, to permit it to be cabled up with several kilometres of cable.

Example:

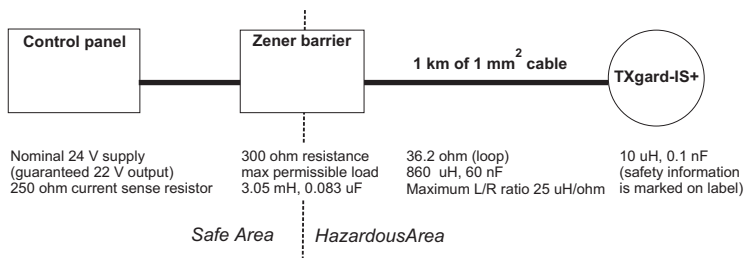

You must refer to the cable specification to discover the exact values of capacitance and inductance.

* In this example, the total inductive load on the output of the zener barrier is 870 uH which is well below its 3,050 uH limit.

* The capacitive load is only 60.1 nF which is below the 83 nF limit of the barrier. So the system is Intrinsically Safe.

In addition to the safety of the system you must also consider: will it work? As described earlier in Appendix F, you must check that the TXgard-IS+ will get a minimum supply of 8 volts at the end of the cable. Here we can count on 22 V at the control panel, and with a maximum current drain of 20 mA, we will lose $(250 + 300 + 36.2 \text{ ohms}) \times 0.02 \text{ amps} = 11.7 \text{ V}$, so the detector will always have at least 10.3 V. However, we have to ensure it does not have its fault current set to "24mA" or it will only get 7.9 V. For longer cable lengths, use cable with 1.5 or 2.5 mm² cores (see section 2.3 for resistance values).

Note 1. You might only need to allow for up to 20 mA, depending on how the instrument is configured. The signal can be limited to the range 4-20 mA using the "Limit -20 mA" option in the Configuration menu (see "Appendix D"). Otherwise the instrument increases signal (gas) current to a maximum of 24 mA. Fault and Inhibit currents can be programmed to be 24 mA in the Configuration menu if desired, but most control panels use 3 mA or less to signal faults.

Note 2. It is worth noting that most 28 V Zener barriers are 300 Ω , which will give another 6 V drop. With an 18 V supply and a 250 Ω sense resistor, this would give a voltage at the end of an 80 Ω loop of min. $18 - 6 - 6 - 2 = 4$ V, which is not enough to drive the TXgard-IS+ (which requires 8 V or more). Therefore when using Zener barriers and high-value sense resistors, ensure the supply voltage is a good 24 V: thus e.g. $24 - 6 - 6 - 2 = 10$ V. Obviously if you have configured the instrument to draw no more than 20 mA (see Note 1), the situation is improved.

Note 3. By loop resistance we mean the total resistance of both wires in the twisted pair cable, that is, one wire going to the detector and one returning. For example, an 80 Ω loop resistance will be 40 Ω out and 40 Ω back. Cable resistance values are usually quoted for a single conductor, thus the value has to be doubled to correctly calculate the loop resistance.

APPENDIX G

SENSOR LIMITATIONS

The sensors used in TXgard-IS+ have limitations common to all such gas sensors, and users should be aware of the points listed below. Crowcon can advise on particular situations and suggest alternative sensors if the instrument is likely to experience extreme conditions.

- Electrochemical gas sensors contain chemicals. The chemicals' performance changes at extremes of temperature; consult Crowcon if the detector will be exposed to ambient temperatures below -20°C or above +40°C.
- Extreme levels of humidity can also cause problems. The sensors are rated for an (average) ambient of 15-90% R.H. However they are used from the tropics to deserts to tundra without this normally being a problem.
- Water should not be allowed to collect on the sensor as this may impede gas diffusion. This is why the sensors are usually mounted on the bottom of the instrument.
- Persistent exposure to high levels of toxic gas will shorten the life of the sensor. If the high level gas is corrosive (e.g. hydrogen sulphide) damage may occur over time to metal components.
- Sensors may be cross sensitive to other gases. If unsure, contact Crowcon or your local agent.
- When used in dusty environments, detectors should be inspected regularly as dust may block the sensor and prevent gas from being detected.

Warranty Statement

This equipment leaves our factory fully tested and calibrated. If within the warranty period, the equipment is proved to be defective by reason of faulty workmanship or material, we undertake at our discretion either to repair or replace it free of charge, subject to the conditions below.

Warranty Procedure

To facilitate efficient processing of any claim, contact our customer support team on +44 (0)1235 557711 with the following information:

Your contact name, phone number, fax number and email address.

Description and quantity of goods being returned, including any accessories.

Instrument serial number(s).

Reason for return.

Obtain a Returns form for identification and traceability purpose. This form may be downloaded from our website 'crowconsupport.com', along with a returns label, alternatively we can 'email' you a copy.

Instruments will not be accepted for warranty without a Crowcon Returns Number ("CRN"). It is essential that the address label is securely attached to the outer packaging of the returned goods.

The guarantee will be rendered invalid if the instrument is found to have been altered, modified, dismantled, or tampered with. The warranty does not cover misuse or abuse of the unit.

Any warranty on batteries may be rendered invalid if the use of an unauthorized charger is proven. Non-rechargeable batteries are excluded from this warranty.

Warranties on sensors assume normal usage, and will be rendered invalid if the sensors have been exposed to excessive concentrations of gas, extended periods of exposure to gas or have been exposed to 'poisons' that can damage the sensor, such as those emitted by aerosol sprays

Warranty Disclaimer

Crowcon accept no liability for consequential or indirect loss or damage howsoever arising (including any loss or damage arising out of the use of the instrument) and all liability in respect of any third party is expressly excluded.

This warranty does not cover the accuracy of the calibration of the unit or the cosmetic finish of the product. The unit must be maintained in accordance with the Operating and Maintenance Instructions.

The warranty on replacement consumable items (such as sensors) supplied under warranty to replace faulty items, will be limited to the unexpired warranty of the original supplied item.

Crowcon reserves the right to determine a reduced warranty period, or decline a warranty period for any sensor supplied for use in an environment or for an application known to carry risk of degradation or damage to the sensor.

Our liability in respect of defective equipment shall be limited to the obligations set out in the guarantee and any extended warranty, condition or statement, express or implied statutory or otherwise as to the merchantable quality of our equipment or its fitness for any particular purpose is excluded except as prohibited by statute. This guarantee shall not affect a customer's statutory rights.

Crowcon reserves the right to apply a handling and carriage charge whereby units returned as faulty, are found to require only normal calibration or servicing, which the customer then declines to proceed with.

For warranty and technical support enquiries please contact::

Customer Support

Tel +44 (0) 1235 557711

Fax +44 (0) 1235 557722

Email 'warranty@crowcon.com'

